



ESSENCE BLUE 3

A buffet with cold blown-air well unit for the quality presentation of food. With a sturdy chrome plated frame on wheels and timber cladding with energy efficient LED lighting, it is suitable for the display of food for hotels, government services, catering companies, mining kitchens and buffet restaurants.

MODEL NO:	3/1
DIMENSIONS STRUCTURE FREE:	1233mm x 1012mm x 1100mm
DIMENSIONS WITH STRUCTURE:	1233mm x 860mm x 1595mm
DEEP INNER TUB:	159mm
STORAGE CAPACITY:	3 GN1/1
TEMPERATURE:	+4/ +8°C
CLIMATE CLASS INDEX:	3
REFRIGERATION POWER W(-10°C/+45°C):	2058
REFRIGERANT FLUID R404A(g):	900
ABSORBED POWER:	972
MAX ABSORBED CURRENT:	9.60
VOLTAGE AND NET FREQUENCY:	230v/50Hz

BUFFET WITH COLD BLOWN-AIR WELL ESSENCE BLUE 3

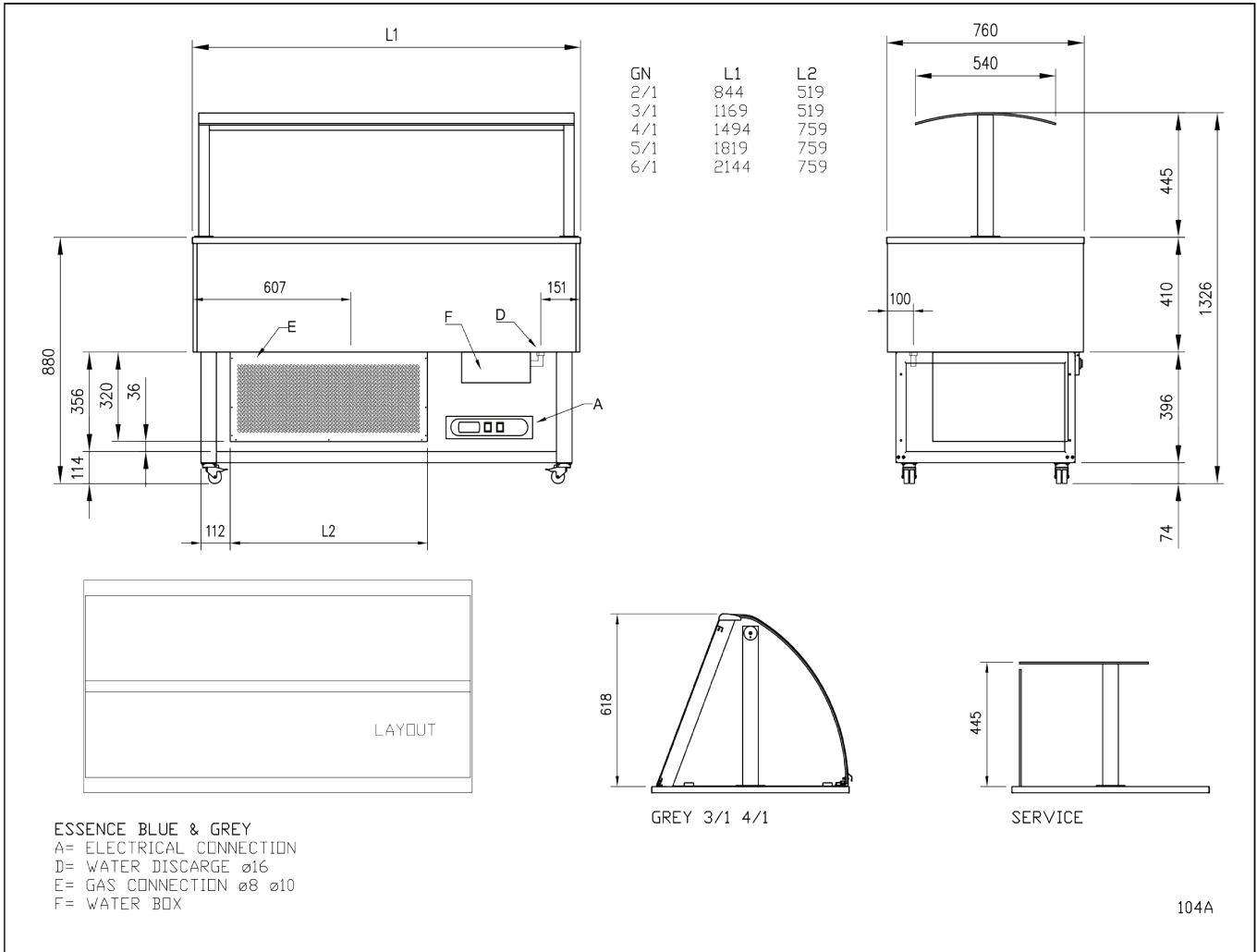

104A



Exclusive importer for Afinox

8 Guthrie Street, Osborne Park
 Western Australia, 6017
 Perth Australia

T: +61 08 9242 7521
 F: +61 08 9242 7168

sales@ableproducts.com.au
ableproducts.com.au